

Model: Steelworx Single Post Square Shelter, 12'
Model # SPSQ-12-SW

Manufacturing Mission: To provide all prefabricated components and installation instructions for a single post 12' square (measured from eave to eave) free standing bolt together, tubular steel constructed shelter kit.

Design Criteria: Structure is typically designed for a 30 lb live load and a 100 mph wind load capacity. All structural members are ASTM A-500 U.S. grade B steel. Welded connection plates shall be ASTM A-36 hot rolled steel. All welding performed to latest AWS standards by ASTM Certified welders and provided in accordance to same.

Tubular Steel Columns and Beams: Standard column dimension shall be 8" x 8" x 3/16" tubular steel welded to 5/8" base plate (footing design provided separately). Interior support beams are 5" x 4" x 1/8" and 4" x 3" x 1/8". Economy Version (EV) of this shelter model for residential or less stringent design locations are available with smaller more economical member sizes.

Roofing: 24 Ga. pre-cut steel panels with Kynar 500 finish in a variety of colors with white underside. Standard roof slope is a 4/12 pitch with a eave height of 7'-0". Also available with 6/12 or 8/12 pitch roof. Attached to structural framing with engineered strength self tapping screws.

Frame Finish: All steel framework will undergo a three step powder coat application that begins with welded raw steel being sand blasted to a white condition to eliminate contaminants and oils. Then a zinc-rich primer is applied and baked at 400°F, followed by a corrosion protective TGIC Polyester powder coat, electro-statically applied and cured at 400°F. A large selection of standard colors are available.

Foundation: All columns need to be anchored to concrete footings. Columns can be surface mounted with anchor bolts at or below finish slab elevation or they can be embedded directly into the footing. Optional base plate covers are available at an additional cost.

Hardware: All structural hardware provided and to be A-325 or B7 as required.

Shop Drawing: The fabricator shall furnish a complete set of installation drawings.

Not Included: Concrete work of any kind, unloading of product and installation.

Additional Options:

- Flexibility of Design
Such as: Height and Pitch
- Additional Engineering
- Variety of Colors
- Decorative Railings, Lattice, Braces, Trim, etc.
- Cupolas and Rooftop Accs.
- Column Style Variations
- Lexan Wind Screens
- Standing Seam Roofing
- Composite Finished Ceiling
- Solar Panels & Solar Lighting
- Site Furnishings and Accs.

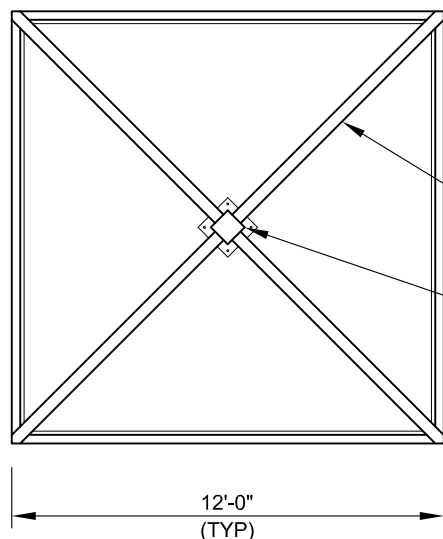

FRAMING PLAN
SCALE: 3/16" = 1'-0"

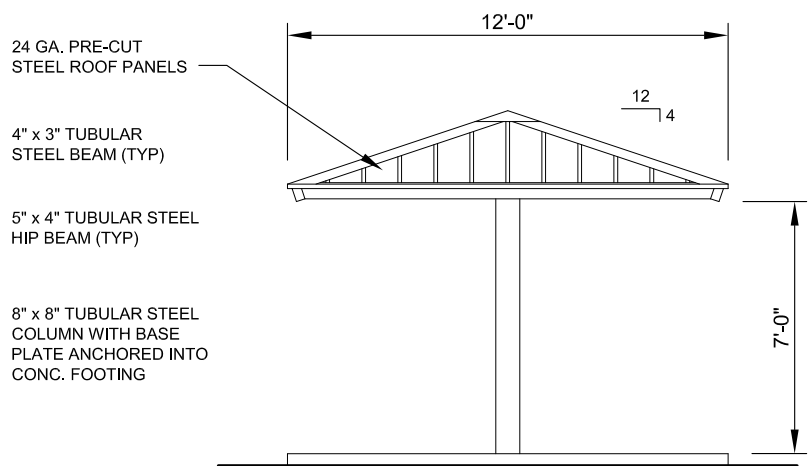

ELEVATION
SCALE: 3/16" = 1'-0"



11800 East 9 Mile Road
 Warren, MI 48089
 Office: (586) 486-1088
 Fax: (586) 754-9130
 Toll Free: (800) 657-6118
 Email: info@coverworx.net
 www.CoverWorx.net

Steelworx Single Post Square Shelter - 12'

Model: SPSQ-12-SW

DESIGN SPECIFICATIONS