

Model: Steelworx Two Post Gable Shelter, 6' x 8'
Model # GA-0608-SW-2P

Manufacturing Mission: To provide all prefabricated components and installation instructions for a 6' wide (measured from eave to eave) by 8' long free standing bolt together, tubular steel constructed shelter kit.

Design Criteria: Structure shall be designed for a 20 lb live load and a 100 mph wind load capacity, but can be designed based on specific site requirements upon request. All structural members are ASTM A-500 U.S. grade B steel. Welded connection plates shall be ASTM A-36 hot rolled steel. All welding performed to latest AWS standards by ASTM Certified welders and provided in accordance to same.

Tubular Steel Columns and Beams: Standard columns shall be 6" x 6" tubular steel welded to base plate (footing design provided separately). Main support beams are 6" x 4" and purlins are 6" x 3". All framing connections are done using A325 grade bolts within concealed access openings from above and will later be concealed by the roofing. All roof framing shall be flush against the roof decking to eliminate the possibility of bird nesting. Steel sizes are preliminary and may change upon final engineering based on actual site conditions and load requirements (site specific engineering shall be an additional cost).

Roofing: 24 Ga. pre-cut steel panels with Kynar 500 finish in a variety of colors with white underside. Standard roof slope is a 4/12 pitch with a eave height of 7'-2". Also available with 6/12 or 8/12 pitch roof. Attached to decking with exposed fasteners painted to match roof.

Frame Finish: All steel framework will receive a corrosion protective TGIC Polyester powder coat, electro-statically applied and cured at 400°F. A large selection of standard colors are available.

Foundation: All columns need to be anchored to concrete footings. Columns can be surface mounted with anchor bolts at or below finish slab elevation or they can be embedded directly into the footing. Optional base plate covers are available at an additional cost.

Hardware: All structural hardware and roofing fasteners shall be provided.

Warranty: 10 years against manufacturer defects.

Not Included: Concrete work of any kind, unloading of product and installation.

Additional Options:

- Flexibility of Design
 - Such as: Height and Pitch
- Additional Engineering
- Variety of Colors
- Decorative Railings, Lattice, Braces, Trim, etc.
- Cupolas and Rooftop Accs.
- Column Style Variations
- Lexan Wind Screens
- Tongue & Groove Roof Decking
- Asphalt Shingles, Standing Seam, Cedar Shake, or Clay Tile Roofing
- Composite Finished Ceiling
- Solar Panels & Solar Lighting
- Site Furnishings and Accs.

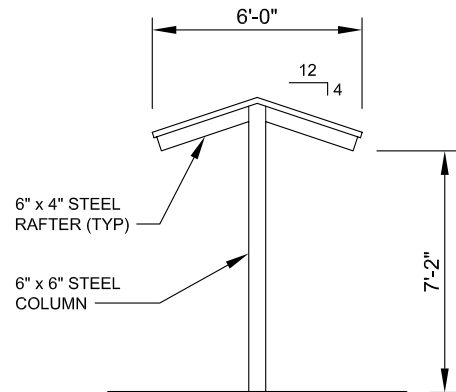

SIDE ELEVATION
SCALE: NTS

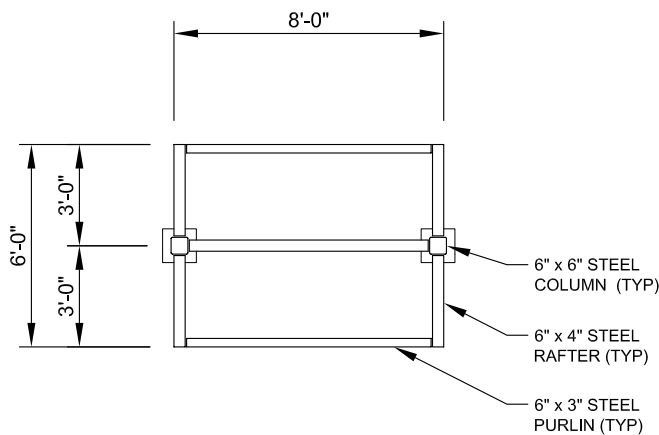

FRAMING PLAN
SCALE: NTS

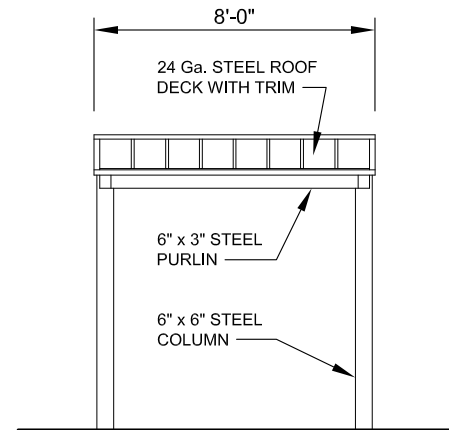

FRONT ELEVATION
SCALE: NTS



11800 East 9 Mile Road
 Warren, MI 48089
 Office: (586) 486-1088
 Fax: (586) 754-9130
 Toll Free: (800) 657-6118
 Email: info@coverworx.net
 www.CoverWorx.net

Steelworx Two Post Gable Shelter - 6' x 8'

Model: GA-0608-SW-2P

DESIGN SPECIFICATIONS